

Article number: 0101226
 Description: Retaining ring A 480 DIN 471
 Spring steel
 Note: Fitted with ZGA pilers

Measures

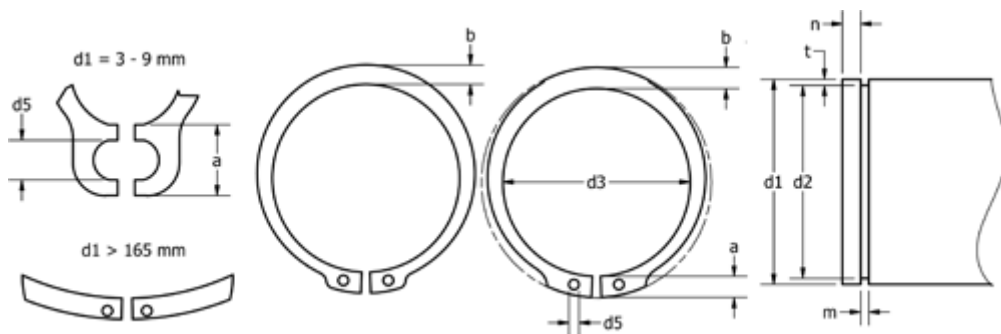

a max	=	FN kN	= 1489.0	s	= 7.00
AN mm ²	= 8935.0	FRg kN	= 119.00	t	= 6.00
b	= 26.0	FR kN	= 1383.00	tol	= -1.00
d1	= 480	g	= 7.0	tol	= -0.15
d2	= 468.0	K kN-mm	= 3169.00	tol	= +1,00-2,00
d3	= 460.0	m min	= 7.20	Tong	= ZGA-7
d5 min	= 6.0	n abl x 1000	= 0.5	Weight kg/1000	= 999.999
Description	= A480	Nominal drive	= 18.0		